

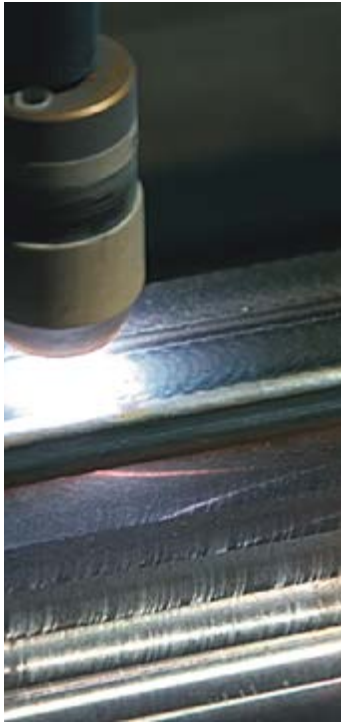

www.durmat.com

DURMAT® PTA Powders



WEAR SOLUTIONS

With Creative Ideas for Practical Solutions

DURUM VERSCHLEISS-SCHUTZ GMBH was established in 1984 as a manufacturer of advanced hard-facing products. Today DURUM has production and service centres in Brazil, France and the USA and exports to more than 80 countries all over the world!

DURUM provides high performance products for Welding and Thermal Spraying. DURUM is a global market leader in the supply of specialized overlaying consumables that can be applied by a range of processes including: Flux-Cored Wire Welding, Plasma Transferred Arc (PTA) Welding, Oxy-acetylene Welding, Shielded Metal Arc Welding, Thermal Spraying.

Besides Willich (Germany) DURUM Group maintains production and workshop facilities in Brazil (São Paulo), France (Saint Victor) and the USA (Houston TX). We also support a network of independent agencies throughout the world. We meet demanding requirements of today's industry with a wide array of Welding and Thermal Spray technologies.

The company employs national and international PhD's; welding engineers and independent experts from well known and respected universities, which ensures that constant material and process development is achieved to the highest standards.

DURUM focuses on "continuous development" and sets a significant annual budget aside for research and development including new product development, product enhancement and the development of highly specialised solutions to the most challenging applications in the industry.



DIN EN ISO 9001:2008
Cert. No.: 01 100 040463

Our wide range of specialized surface hard-facing materials includes:

- Tungsten Carbide Rods for Oxy-acetylene Welding
- Nickel-, Cobalt- and Iron-based Flux-Cored Wire
- FCAW wires with Tungsten Carbide and complex carbides to provide extremely hard and tough coatings, used principally for extreme wear applications
- Tungsten Carbides, Complex Carbides and Chromium Carbides for manual Arc Welding
- PTA Welding Powders
- PTA machines, torches and powder feeders
- Powders and Wires for Laser Cladding
- Powders for Oxy-acetylene Welding and Spraying
- Fused Crushed and Spherical Fused Tungsten Carbides
- Pre-manufactured replacement wear parts
- Thermal Spray Powders (conforming to DIN EN 1274)
- Thermal Spray Wires (conforming to DIN EN 14919)

PTA Welding

PTA Welding

Plasma-Transferred-Arc process (PTA) has been in use since 1962. The application for PTA welding is very extensive.

Plasma-Transferred-Arc (PTA) is used to protect parts, which are subject to extreme wear conditions such as: heat, abrasion, corrosion, erosion, adhesive and abrasive wear etc.

PTA-welding is split up into micro (MPTA), conventional (NPTA) and high performance (HPTA) plasma-powder-welding. The deposition rate varies from 0.1 to 0.5 kg/h for smallest components with MPTA, over 6 kg/h for the conventional PTA and up to 20 kg/h for HPTA.

Depending on chosen welding parameters we can expect dilution rates below 10 %. Special torches and powder feeding systems have been developed to meet the specific demands. The process preserves its positive properties concerning low dilution and good controllability during the whole application process.

The principle of the PTA process is illustrated in the picture below.

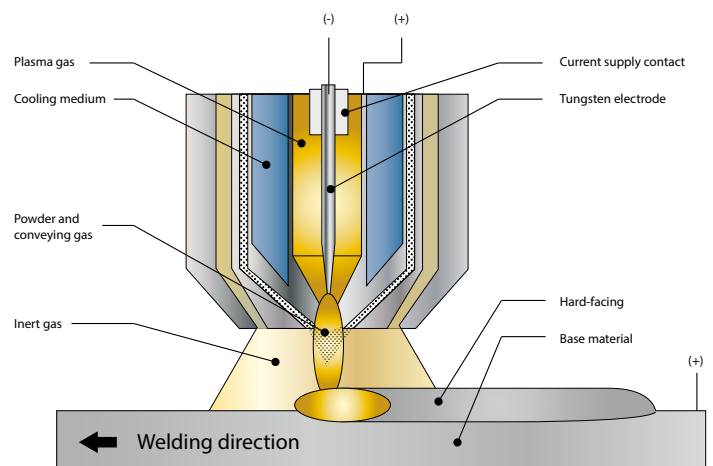

Powder Particle Distribution

All powders in this guide reflect nominal powder particle size distributions. The majority of powder particles by weight is within the stated size range. Only a small amount being coarser or finer. In general, particles larger or equal to 45 μm are measured by sieve analysis (ASTM B214). DURMAT® PTA Powders are available in standard grain size distribution **S** (-125 / +45 μm); **M** (-160 / +63 μm) and **H** (-180 / +75 μm). Other grain size distributions are available on request.

Standard Grain Size Distributions		
S	M	H
-125 / +45 μm	-160 / +63 μm	-180 / +75 μm



Tungsten Carbide Powders

DURMAT® FTC

General information:

Fused Tungsten Carbide (FTC) is an extremely hard, wear resistant material. Its abrasion resistance is superior in terms of wear resistance to all other commercially available materials except diamond. It is far superior to any of the chromium carbide products presently in use and will always deliver very positive test results by comparison. This material forms the basis of all DURUM's abrasion-resisting products.

The properties of the FTC are very much dependent on its structure. FTC which demonstrates at least an 80 % "feather" structure has a macro-hardness of approximately 2,000 HV₃₀. The micro-hardness of this material has been measured at 2,300 - 2,500 HV_{0,1}.

FTC has a carbon content of 3.8 - 4.1 %. This corresponds to a ratio of 78 - 80 % W₂C and 20 - 22 % WC. Careful attention must be paid during the processing and application of products containing FTC, that the temperature does not exceed 1,800 °C. Higher temperatures would cause an alteration in the structure resulting in a loss of hardness. If this excessive overheating occurs during the welding procedure, an unproportionately high amount of FTC will be dissolved in the iron matrix, which would also result in a reduction of the material's superior ability to resist wear.

Product	-	DURMAT® FTC	DURMAT® SFTC
Alloy type	-	WC - W ₂ C	WC - W ₂ C
Parameter	Unit	Typical data	
C-TOTAL	%	3.8 - 4.1	3.8 - 4.1
C-FREE	%	0.1 max.	0.1 max.
O ₂ SIEVE RANGE	%	0.05 max.	0.05 max.
O ₂ SUB SIEVE RANGE	%	0.2 max.	0.2 max.
Fe	%	0.3 max.	0.3 max.
Co	%	0.3 max.	0.3 max.
Hardness	HV _{0,1}	2,360	3,000
Structure	-	mainly feather	fine
Density	g/cm ³	16 - 17	16 - 17
Melting point	°C/°F	2,860/5,176	2,860/5,176



DURMAT® SFTC

General information:

DURMAT® Spherical Fused Tungsten Carbide (SFTC) is the most wear resistant Fused Tungsten Carbide we can offer.

These spherical fused tungsten carbide particles show a fine non-acicular structure with a higher hardness than conventional FTC (> 3,000 HV_{0,1}). The increased apparent density combined with a better flowability enables an increase of hard particles in wear resistant coatings and components produced by infiltration.

Using powder metallurgical processes, it is possible to produce parts of nearly any shape, which can contain hard materials or diamonds together with a metal binder and SFTC, reinforcing the hardness of diamond tools. Excellent for deep well drilling tools and rods, crusher jaws, mixers, concrete & stone saws, hot-pressed tools, screens & conveyors, extrusion housings and hard additives to diamond bits and saws.

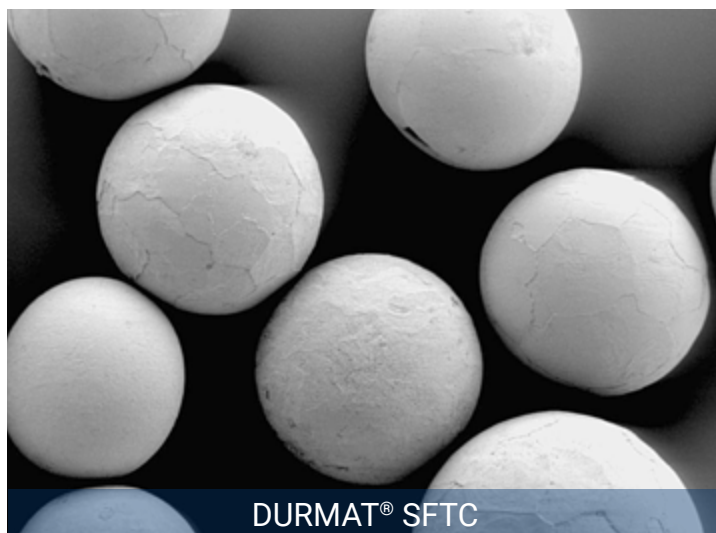

DURMAT® RF 13

According to their outstanding mechanical properties, hard-facing alloys based on Tungsten Carbide and cobalt take a central position in wear protection. The high demands, which are placed on the wear resistance of such alloys these days, have led to increasingly finer micro structures with optimized compositions, allowing improved, higher performance alloys to be achieved.

Their characteristic, fine-structured composition with crystallite grain sizes of max. 400 nm is their trademark and a guarantee for high wear resistance. Compared to common Tungsten Carbide-Cobalt alloys we have achieved better wear resistance, by using smaller WC structure. Our DURMAT® RF 13 development using fine-structured WC has resulted in hardness of approximately 1,750 HV_{0,5}.

The higher hardness of the nano-scale hard-facing alloy associated with the decreasing WC grain size reduces wear from abrasion considerably. The harder "hard metal" counters abrasion with a greater resistance. Wear progresses significantly slower, as the binding metal layer between the fine grain hard-facing crystallites is exceptionally thin, making it harder to wash out. Due to this structural attribute, only very small hard-facing particles are torn out.

The spherical shape represents a further form of protection, which is further stabilized by the small grain size; a lot more energy has to be applied for fragmentation of small particles compared to large particles due to the presence of less defects.

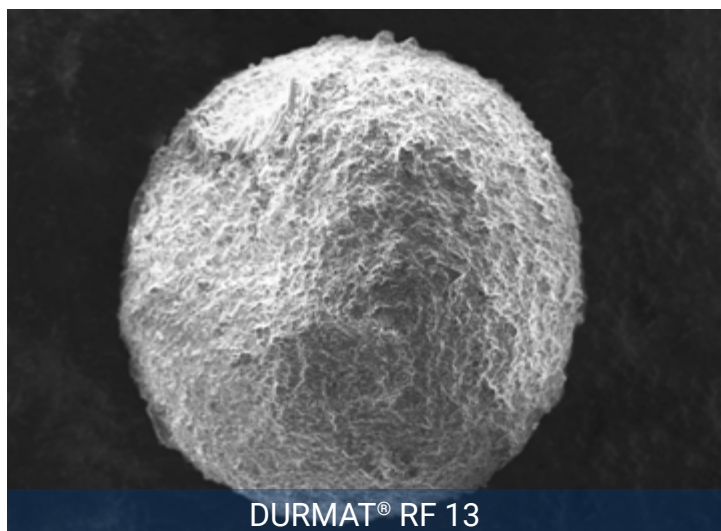

A characteristic, higher wear resistance also occurs with regard to corrosive wear. As a result of the nano-structure and in particular the significantly reduced intermediate binding metal layer, the corrosive media can only reach the cobalt with difficulty, leading to considerable delays in wear. In turn, only the smallest hard-facing particles escape, corrosion is slowed down considerably.

DURMAT® MCWC

The Macro-Crystalline Tungsten Carbide (DURMAT® MCWC) is a fully carburized stoichiometric compound with a carbon content of 6.14 % by weight.

Based on its stable single-phase micro-structure, nearly no dissolution of the Macro-Crystalline Tungsten Carbides is observed after the welding process. MCWC has good weldability with nickel-based alloys during the PTA application process. The thermodynamically more stable MCWC has a blocky shape with low decarburization during processing.

The carbide hardness amounts 1,700 - 2,000 HV_{0,1}. The DURMAT® MCWC can stay in service up to 500 °C (930 °F).

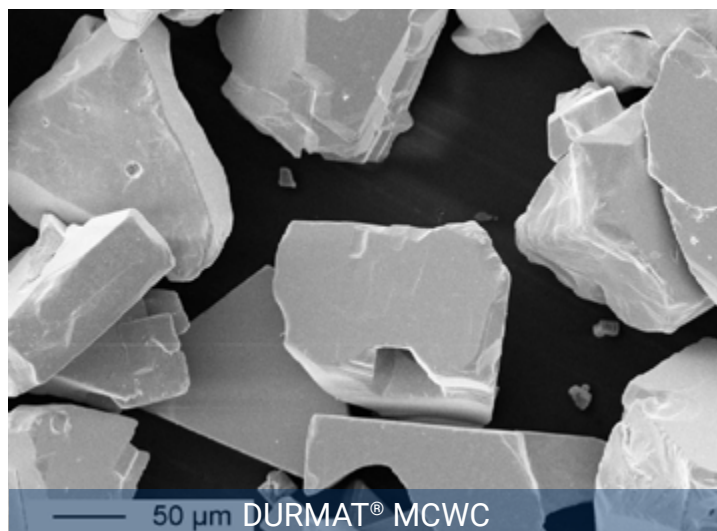

DURMAT® NiCrB - Matrix Alloys

PTA metal powders for wear resistant hard-facings.

General characteristics:

DURMAT® NiCrB - PTA-Matrix powders have an excellent resistance to wear, heat and corrosion. Based on the low friction coefficient and depending on the selected hardness, NiCrB-coatings have excellent gliding properties on high tensile strength steels. Due to the low melting point (approx. 1,020 - 1,080 °C) the powders show a very good weldability and can be applied with low energy. They are in use for hard-facing of conveyor screws, wear rings or parts for the glass industry, e.g. glass moulds or for buffer layers. The powders can be mixed with Fused Tungsten Carbide DURMAT® FTC to provide maximum wear resistance.

DURMAT®	Cr-Content*	Grain size	Structure	Hardness
33 PTA	4 - 7	S / M / H	Ni-Cr-Boride	29 - 33 HRC
54 PTA	13 - 16	S / M / H	NiCu-Cr-Boride	56 - 61 HRC
55 PTA	13 - 17	S / M / H	Ni-Cr-Boride	51 - 56 HRC
56 PTA	6 - 9	S / M / H	Ni-Cr-Boride	37 - 41 HRC
57 PTA	13 - 17	S / M / H	Ni-Cr-Boride	57 - 61 HRC
58 PTA	11 - 15	S / M / H	Ni-Cr-Boride	47 - 51 HRC

* by weight %

DURMAT® NiB - Matrix Alloys

PTA metal powders for wear resistant hard-facings.

General characteristics:

DURMAT® NiB - PTA-Matrix powders are resistant to heavy abrasion and heat. Its extreme hardness allows for excellent sliding on high tensile strength steels. Based on the low melting temperature the Cr-free powders are recommended in combination with Fused Tungsten Carbide DURMAT® FTC for wear resistant applications. The powder can be used for buffer layers before applying FTC-blended powders like DURMAT® 61 PTA.

DURMAT®	Type	Grain Size	Structure	Hardness
30 PTA	NiSF	S / M / H	Ni-Boride	≈ 30 HRC
40 PTA	NiSF	S / M / H	Ni-Boride	≈ 40 HRC
59 PTA	NiSF	S / M / H	Ni-Boride	≈ 50 HRC



DURMAT® NiCrB-TC Powders, blend

PTA metal powders for wear resistant hard-facings.

General characteristics:

Depending on the application DURMAT® NiCrB-TC powders can contain a high volume of Tungsten Carbides, such as Fused Tungsten Carbide DURMAT® FTC, Spherical Fused Tungsten Carbide DURMAT® SFTC, Macro-crystalline Tungsten Carbide DURMAT® MCWC and/or DURMAT® RF 13.

DURMAT®	Type	Grain Size	Carbide mass*	Matrix Hardness
38 PTA	NiCr - FTC	S / M / H	30 %	≈ 40 HRC
63 PTA	NiCr - SFTC	S / M / H	60 %	37 - 41 HRC
65 PTA	NiCr - SFTC	S / M / H	60 %	47 - 51 HRC
79 PTA	NiCr - FTC	S / M / H	60 %	57 - 61 HRC
84 PTA	NiCr - MCWC	S / M / H	60 %	30 - 33 HRC
85 PTA	NiCr - MCWC	S / M / H	60 %	47 - 51 HRC
110 PTA	NiCr - RF 13	S / M / H	60 %	37 - 41 HRC

* by weight %

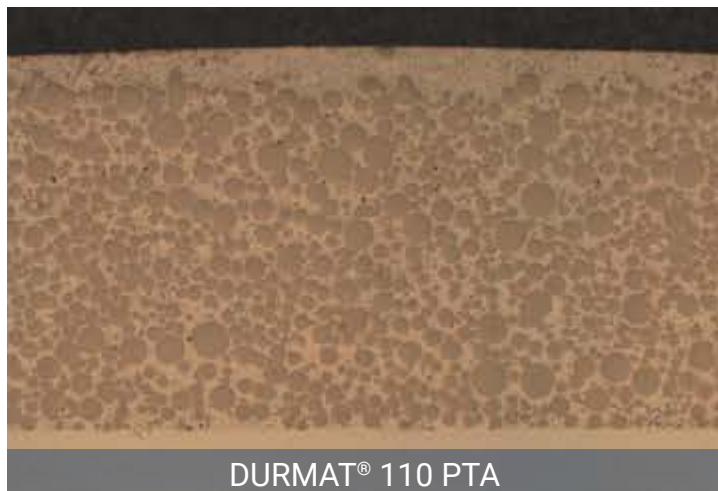

DURMAT® NiB-TC Powders, blend

PTA metal powders for wear resistant hard-facings.

General characteristics:

Depending on the application DURMAT® NiB - PTA powders can contain a high volume of Tungsten Carbides, such as Fused Tungsten Carbide DURMAT® FTC and/or Spherical Fused Tungsten Carbide DURMAT® SFTC.

DURMAT®	Type	Grain Size	Carbide mass*	Matrix Hardness
61 PTA	NiB-FTC	S / M / H	60 %	≈ 50 HRC
62 PTA	NiB-SFTC	S / M / H	60 %	≈ 50 HRC
93 PTA	NiB + FTC/SFTC Special Blend	S / M / H	60 %	≈ 50 HRC

* by weight %

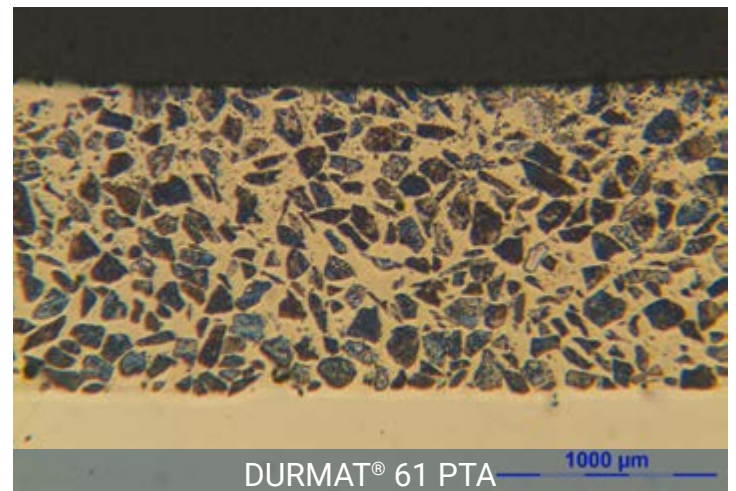

Special Hard-facing Powder

DURMAT® NiFe - Alloys and TC-Blends

PTA metal powders for wear resistant hard-facings.

General characteristics:

DURMAT® NiFe - Alloys have an excellent resistance to wear. Based on the high Fe-content this alloy is a good economic alternative to standard NiSF-alloys. Based on special additives the melting point of this alloy is approx. 1,050 °C and similar to standard NiSF-alloys. The powders can be mixed with Fused Tungsten Carbide DURMAT® FTC, Spherical Fused Tungsten Carbide DURMAT® SFTC and/or Macro-Crystalline Tungsten Carbide DURMAT® MCWC to provide maximum wear resistance.

DURMAT®	Type	Grain size	Carbide Content*	Matrix Hardness
71 PTA	NiFe-FTC	S / M / H	60 %	50 - 55 HRC
72 PTA	NiFe-SFTC	S / M / H	60 %	50 - 55 HRC
73 PTA	NiFe-MCWC	S / M / H	60 %	50 - 55 HRC
77 PTA	NiFe	S / M / H	Matrix	50 - 55 HRC

* by weight %

DURMAT® NiCrMo - Alloys and TC-Blends

PTA metal powders for wear resistant hard-facings.

General characteristics:

DURMAT® NiCrMo - PTA-Matrix powders have an excellent resistance to corrosion (e.g. in acids with chloride content) and oxidation. The coatings show high ductility values. The main application field is the weld surfacing of components for the chemical industry, components for off-shore operations, oil exploration, valves and fittings. The powders can be mixed with Fused Tungsten Carbide DURMAT® FTC and/or Spherical Fused Tungsten Carbide DURMAT® SFTC to provide maximum wear resistance.

DURMAT®	Type	Grain size	Carbide Content*	Matrix Hardness
625 PTA	NiCrMoNb	S / M / H	-	≈ 250 HV
476 PTA	NiCrMo	S / M / H	-	≈ 250 HV
401 PTA	NiCrMoNb + FTC	S / M / H	50 %	≈ 55 HRC
411 PTA	NiCrMoNb + SFTC	S / M / H	50 %	≈ 58 HRC

* by weight %

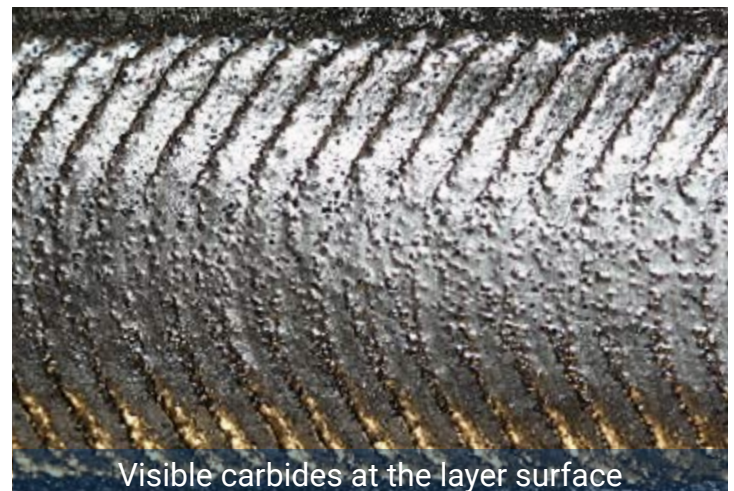
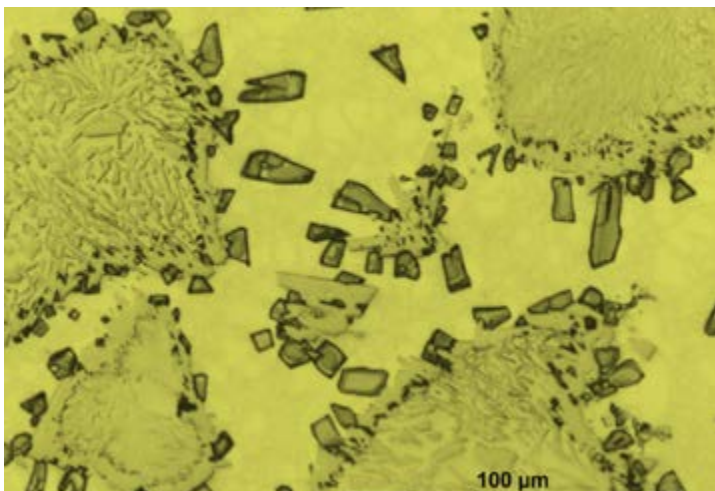

DURMAT® TC-SC - Blends

PTA metal powders for wear resistant hard-facings.

General characteristics:

DURMAT® TC-SC - PTA powders are resistant to heavy abrasion and heat. Based on the mixture of different complex TC- and SC-carbides in combination with Fe- and Ni-alloys the powders are recommended for extremely wear resistant applications.



DURMAT® Laser-Like PTA

DURMAT®	Type	Grain Size	Carbide Content*	Matrix Hardness
66 PTA	NiCrB + SC	S / M / H	≈ 20 %	57 - 61 HRC
67 PTA	NiB + FTC + SC	S / M / H	< 65 %	≈ 50 HRC
68 PTA	NiB + SFTC + SC	S / M / H	< 65 %	≈ 50 HRC
74 PTA	NiFe + FTC + SC	S / M / H	60 %	≈ 50 HRC
108 PTA	FeCrMn + RF13	S / M / H	60 %	< 500 HB
109 PTA	FeCrMn + RF13	S / M / H	60 %	< 400 HB

* by weight %



DURMAT® 66 PTA 50 µm



DURMAT® 67 PTA

DURMAT® FeCrC - Alloys

PTA metal powders for wear resistant hard-facings.

General characteristics:

DURMAT® Fe Cr C - PTA powders have an excellent resistance to wear. Depending on the application powders are available for impact and moderate abrasive wear or against heavy abrasion. Based on the Cr and C content the powders forms eutectic and primary CrC carbides.

DURMAT®	Type	Grain Size	Structure	Hardness
600 PTA	FeCrC	S / M / H	Austenitic-martensitic	55 - 58 HRC
601 PTA	FeCrC	S / M / H	Austenitic-martensitic	57 - 60 HRC
536 PTA	FeCr-MoWV	S / M / H	Martenistic	≈ 58 HRC
559 PTA	FeCrC	S / M / H	FeCrC-martensitic	58 - 60 HRC
564 PTA	FeCrWV	S / M / H	FeCrC-martensitic	60 - 64 HRC

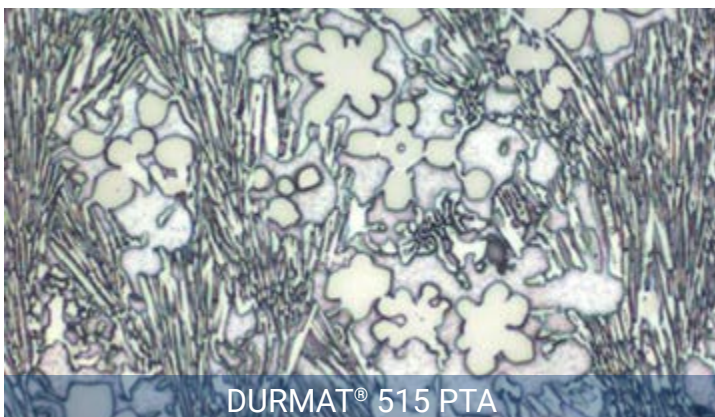
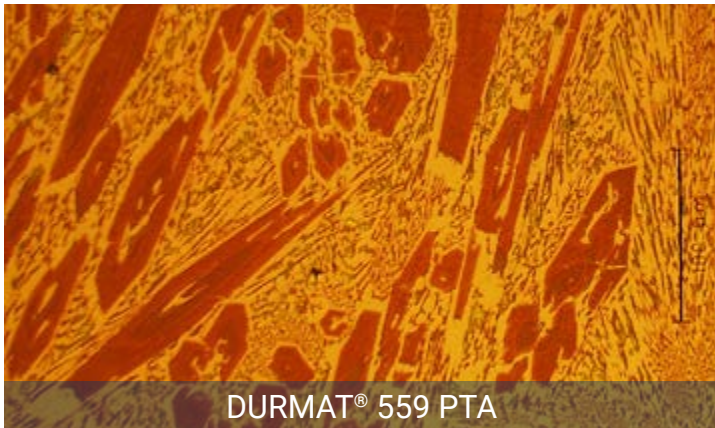

DURMAT® FeCrVC - Alloys

PTA metal powders for special technical applications.

General characteristics:

DURMAT® Fe Cr VC - PTA powders are highly resistant to fine abrasion and impact. The iron based matrix alloy can be martensitic, chromium-martensitic according to the requirements. FeCrVC-coatings show a homogeneous and fine distribution of vanadium carbide ($\approx 2,900 \text{ HV}_{0,1}$) in a martensitic matrix.

DURMAT®	Type	Grain Size	Structure	Hardness
505 PTA	FeCrVC	S / M / H	Martensitic	55 - 60 HRC
506 PTA	FeCrVC	S / M / H	Martensitic, blend	58 - 62 HRC
507 PTA	FeCrVC	S / M / H	Martensitic, blend	60 - 65 HRC
515 PTA	FeCrVC	S / M / H	Martensitic, free Cr	58 - 60 HRC

DURMAT® FeCrMn - Alloys

PTA metal powders for wear resistant hard-facings.

General characteristics:

DURMAT® Fe - PTA powders with high ductility and crack resistance. CrNiMo-alloy with less carbon or impact-resistant austenitic alloy with Mn and Cr are also suited for use as moderating layer.

DURMAT®	Type	Grain Size	Structure	Hardness
516 PTA	FeCrMn	S / M / H	CrNiMo-Alloy	215 HB
520 PTA	FeCrMn	S / M / H	CrMn-austenitic	170 / 400* HB
525 PTA	FeCrMn	S / M / H	CrMn-austenitic	250 / 500* HB

* after work hardening

Hard-facing Co-Alloys and Co-TC Blends

DURMAT® Co - Alloys

Cobalt based alloys for PTA.

General characteristics:

DURMAT® cobalt base alloys contain the elements of cobalt, chromium and carbon as main parts. Additives of molybdenum, tungsten and nickel are added to these depending on alloy type and application. DURMAT® Cobalt-base hard alloys have a high resistance to adhesion, abrasion, erosion, thermal shock, cavitation, gliding etc. They are preferably used at higher temperatures because they retain their hardness and wear-resistance. Overlays are additionally resistant against oxidation, corrosion and tinding.

DURMAT®	Grain Size	Structure	Hardness
S1 PTA	S / M / H	Co-Cr-W	51 - 60 HRC
S6 PTA	S / M / H	Co-Cr-W	40 - 46 HRC
S12 PTA	S / M / H	Co-Cr-W	43 - 53 HRC
S21 PTA	S / M / H	Co-Cr-Mo-Ni	27 - 40 HRC**
S190 PTA	S / M / H	Co-Cr-W-Ni	55 - 60 HRC

** depending on the degree of work hardening

DURMAT® Co-TC - Alloys

Cobalt based alloys with hard alloying elements for PTA.

General characteristics:

DURMAT® Co-TC Alloys were developed for applications, in which extreme wear is combined with high temperatures and corrosive media. Their chemical composition accounts for the excellent dry-running properties of DURMAT® Co-TC Alloys and makes them very suitable for use in adhesive wear situations. The powders are mixed with Fused Tungsten Carbide DURMAT® FTC, Spherical Fused Tungsten Carbide DURMAT® SFTC and DURMAT® RF 13 to provide maximum wear resistance.

DURMAT®	Type	Grain Size	Carbide Content*	Matrix Hardness
921 PTA	Co-Cr-W + SC	S / M / H	20 %	43 - 53 HRC
922 PTA	Co-Cr-W + FTC	S / M / H	60 %	43 - 53 HRC
923 PTA	Co-Cr-W + SFTC	S / M / H	60 %	43 - 53 HRC
924 PTA	Co-Cr-W + RF13	S / M / H	60 %	43 - 53 HRC
961 PTA	Co-Cr-W + SC	S / M / H	20 %	40 - 46 HRC
962 PTA	Co-Cr-W + FTC	S / M / H	60 %	40 - 46 HRC
963 PTA	Co-Cr-W + SFTC	S / M / H	60 %	40 - 46 HRC
964 PTA	Co-Cr-W + RF13	S / M / H	60 %	40 - 46 HRC

* by weight %

DURMAT®	Typical chemical composition of weld metal (wt.-%)								
	C [%]	Si [%]	Mn [%]	Cr [%]	W [%]	Mo [%]	Ni [%]	Fe [%]	Co [%]
S1 PTA	2.5	< 2	< 0.5	30	13	< 1	< 2	< 3	bal.
S6 PTA	1.0 - 1.2	< 2	< 0.5	28	4.5	< 1	< 2	< 3	bal.
S12 PTA	1.4	< 2	< 0.5	30	8	< 1	< 2	< 3	bal.
S21 PTA	0.25	< 2	< 0.5	27.5	-	5.4	< 3	< 3	bal.
S190 PTA	3.0 - 3.4	< 2	< 1	26	14	< 1	< 2	< 3	bal.

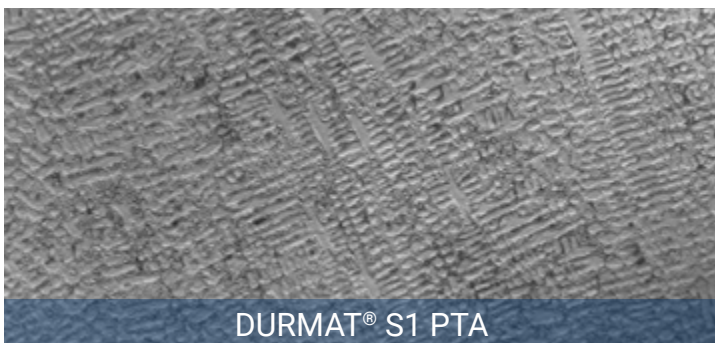

DURMAT® S1 PTA

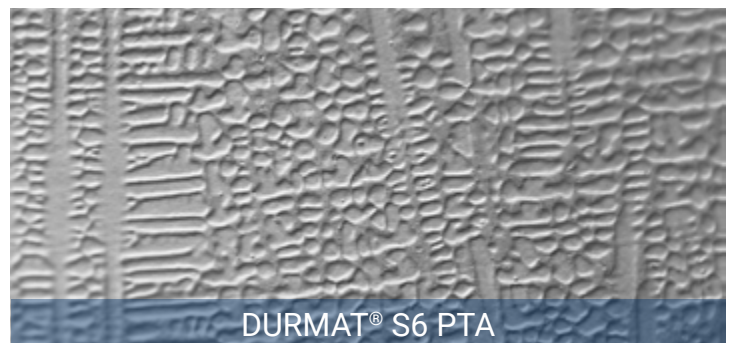

DURMAT® S6 PTA



We understand Wear Protection

- Tungsten Carbide Rods for Oxy-acetylene Welding
- Nickel-, Cobalt- and Iron-based Flux-Cored Wire
- FCAW wires with Tungsten Carbide and complex carbides to provide extremely hard and tough coatings, used principally for extreme wear applications
- Tungsten Carbides, Complex Carbides and Chromium Carbides for manual Arc Welding
- PTA Welding Powders
- PTA machines, torches and powder feeders
- Powders and Wires for Laser Cladding
- Powders for Oxy-acetylene Welding and Spraying
- Fused Crushed and Spherical Fused Tungsten Carbides
- Pre-manufactured replacement wear parts
- Thermal Spray Powders (conforming to DIN EN 1274)
- Thermal Spray Wires (conforming to DIN EN 14919)



DURUM VERSCHLEISS-SCHUTZ GMBH

Carl-Friedrich-Benz-Str. 7
 47877 Willich, Germany
 Tel.: +49 (0) 2154 4837 0
 Fax: +49 (0) 2154 4837 78

info@durum.de
 www.durmat.com